

## MM74HCT164

### 8-Bit Serial-in/Parallel-out Shift Register

#### General Description

The MM74HCT164 utilizes advanced silicon-gate CMOS technology. It has the high noise immunity and low consumption of standard CMOS integrated circuits. It also offers speeds comparable to low power Schottky devices.

This 8-bit shift register has gated serial inputs and CLEAR. Each register bit is a D-type master/slave flip-flop. Inputs A & B permit complete control over the incoming data. A LOW at either or both inputs inhibits entry of new data and resets the first flip-flop to the low level at the next clock pulse. A HIGH level on one input enables the other input which will then determine the state of the first flip-flop. Data at the serial inputs may be changed while the clock is HIGH or LOW, but only information meeting the setup and hold time requirements will be entered. Data is serially shifted in and out of the 8-bit register during the positive going transition of the clock pulse. Clear is independent of the clock and accomplished by a low level at the CLEAR input.

The 74HCT logic family is functionally as well as pin-out compatible with the standard 74LS logic family. All inputs are protected from damage due to static discharge by internal diode clamps to  $V_{CC}$  and ground.

MM74HCT devices are intended to interface between TTL and NMOS components and standard CMOS devices. These parts are also plug-in replacements for LS-TTL devices and can be used to reduce power consumption in existing designs.

#### Features

- Typical propagation delay: 20 ns
- Low quiescent current: 40  $\mu$ A maximum (74HCT Series)
- Low input current: 1  $\mu$ A maximum
- Fanout of 10 LS-TTL loads
- TTL input compatible

#### Ordering Code:

Order Number	Package Number	Package Description
MM74HCT164M	M14A	14-Lead Small Outline Integrated Circuit (SOIC), JEDEC MS-120, 0.150" Narrow
MM74HCT164SJ	M14D	14-Lead Small Outline Package (SOP), EIAJ TYPE II, 5.3mm Wide
MM74HCT164N	N14A	14-Lead Plastic Dual-In-Line Package (PDIP) JEDEC MS-001, 0.300" Wide

Devices also available in Tape and Reel. Specify by appending the suffix letter "X" to the ordering code.

#### Connection Diagram

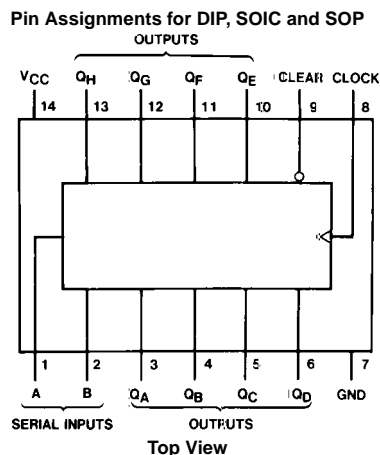

#### Truth Table

Inputs				Outputs			
Clear	Clock	A	B	Q <sub>A</sub>	Q <sub>B</sub>	...	Q <sub>H</sub>
L	X	X	X	L	L		L
H	L	X	X	Q <sub>AO</sub>	Q <sub>BO</sub>		Q <sub>HO</sub>
H	↑	H	H	H	Q <sub>An</sub>		Q <sub>Gn</sub>
H	↑	L	X	L	Q <sub>An</sub>		Q <sub>Gn</sub>
H	↑	X	L	L	Q <sub>An</sub>		Q <sub>Gn</sub>

H = HIGH Level (steady state)

L = LOW Level (steady state)

X = Irrelevant (any input, including transitions)

↑ = Transition from LOW-to-HIGH level.

Q<sub>AO</sub>, Q<sub>BO</sub>, Q<sub>HO</sub> = the level of Q<sub>A</sub>, Q<sub>B</sub>, or Q<sub>H</sub>, respectively, before the indicated steady state input conditions were established.

Q<sub>An</sub>, Q<sub>Gn</sub> = The level of Q<sub>A</sub> or Q<sub>G</sub> before the most recent ↑ transition of the clock; indicated a one-bit shift.

MM74HCT164

Logic Diagram

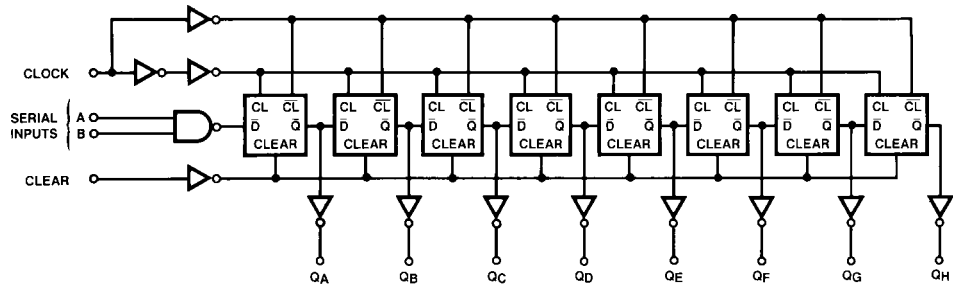

**Absolute Maximum Ratings**(Note 1)

(Note 2)

Supply Voltage ( $V_{CC}$ )	-0.5 to +7.0V
DC Input Voltage ( $V_{IN}$ )	-1.5 to $V_{CC} + 1.5V$
DC Output Voltage ( $V_{OUT}$ )	-0.5 to $V_{CC} + 0.5V$
Clamp Diode Current ( $I_{IK}, I_{OK}$ )	$\pm 20$ mA
DC Output Current, per pin ( $I_{OUT}$ )	$\pm 25$ mA
DC $V_{CC}$ or GND Current, per pin ( $I_{CC}$ )	$\pm 50$ mA
Storage Temperature Range ( $T_{STG}$ )	-65°C to +150°C
Power Dissipation ( $P_D$ )	
(Note 3)	600 mW
S.O. Package Only	500 mW
Lead Temperature ( $T_L$ )	
(Soldering 10 seconds)	260°C

**Recommended Operating Conditions**

	Min	Max	Units
Supply Voltage ( $V_{CC}$ )	4.5	5.5	V
DC Input or Output Voltage ( $V_{IN}, V_{OUT}$ )	0	$V_{CC}$	V
Operating Temperature Range ( $T_A$ )	-40	+85	°C
Input Rise or Fall Times ( $t_r, t_f$ )		500	ns

**Note 1:** Absolute Maximum Ratings are those values beyond which damage to the device may occur.

**Note 2:** Unless otherwise specified all voltages are referenced to ground.

**Note 3:** Power Dissipation temperature derating — plastic "N" package: -12 mW/°C from 65°C to 85°C.

**DC Electrical Characteristics** $V_{CC} = 5V \pm 10\%$  (unless otherwise specified)

Symbol	Parameter	Conditions	$T_A = 25^\circ\text{C}$		$T_A = -40$ to $85^\circ\text{C}$	$T_A = -55$ to $125^\circ\text{C}$	Units	
			Typ	Guaranteed Limits				
$V_{IH}$	Minimum HIGH Level Input Voltage			2.0	2.0	2.0	V	
$V_{IL}$	Maximum LOW Level Input Voltage			0.8	0.8	0.8	V	
$V_{OH}$	Minimum HIGH Level Output Voltage	$V_{IN} = V_{IH}$ or $V_{IL}$		$V_{CC}$	$V_{CC} - 0.1$	$V_{CC} - 0.1$	$V_{CC} - 0.1$	V
		$I_{OUT} = 20 \mu\text{A}$		4.2	3.98	3.84	3.7	V
		$I_{OUT} = 4.0 \text{ mA}, V_{CC} = 4.5V$ $I_{OUT} = 4.8 \text{ mA}, V_{CC} = 5.5V$		5.2	4.98	4.84	4.7	V
$V_{OL}$	Maximum LOW Level Voltage	$V_{IN} = V_{IH}$ or $V_{IL}$		0	0.1	0.1	0.1	V
		$I_{OUT} = 20 \mu\text{A}$		0.2	0.26	0.33	0.4	V
		$I_{OUT} = 4.0 \text{ mA}, V_{CC} = 4.5V$ $I_{OUT} = 4.8 \text{ mA}, V_{CC} = 5.5V$		0.2	0.26	0.33	0.4	V
$I_{IN}$	Maximum Input Current	$V_{IN} = V_{CC}$ or GND		$\pm 0.1$	$\pm 1.0$	$\pm 1.0$	$\mu\text{A}$	
$I_{CC}$	Maximum Quiescent Supply Current	$V_{IN} = V_{CC}$ or GND $I_{OUT} = 0 \mu\text{A}$		8.0	80	160	$\mu\text{A}$	
		$V_{IN} = 2.4V$ or $0.4V$ (Note 4)		1.0	1.3	1.5	mA	

**Note 4:** This is measured per pin. All other inputs are held at  $V_{CC}$  ground.

## AC Electrical Characteristics

$V_{CC} = 5V$ ,  $T_A = 25^\circ C$ ,  $C_L = 15$  pF,  $t_r = t_f = 6$  ns

Symbol	Parameter	Conditions	Typ	Guaranteed Limit	Units
$f_{MAX}$	Maximum Operating Frequency from Clock to Q	50% Duty Cycle Clock	55	35	MHz
$t_{PHL}$ , $t_{PLH}$	Maximum Propagation Delay Clock to Q		17	27	ns
$t_{PHL}$ , $t_{PLH}$	Maximum Propagation Delay from Clear to Q		23	38	ns
$t_{REM}$	Minimum Removal Time, Clear to Clock		3	6	ns
$t_S$	Minimum Set Up Time Data to Clock	$t_H \geq 20$ ns	6	13	ns
$t_H$	Minimum Hold Time Clock to Data	$t_S \geq 20$ ns	1.5	5	ns
$t_W$	Minimum Pulse Width Clock, Preset or Clear		9	16	ns

## AC Electrical Characteristics

$V_{CC} = 5.0V$ ,  $\pm 10\%$ ,  $C_L = 50$  pF,  $t_r = t_f = 6$  ns (unless otherwise specified)

Symbol	Parameter	Conditions	$T_A = 25^\circ C$		$T_A = -40^\circ C$ to $85^\circ C$		$T_A = -55^\circ C$ to $125^\circ C$		Units
			Typ	Max	Min	Max	Min	Max	
$f_{MAX}$	Maximum Operating Frequency	50% Duty Cycle Clock	45	30		25		22	MHz
$t_{PHL}$ , $t_{PLH}$	Maximum Propagation Delay from Clock to Q		20	30		38		45	ns
$t_{PHL}$	Maximum Propagation Delay from Clear to Q		26	41		51		61	ns
$t_{REM}$	Minimum Removal Time Clear to Clock		4	8		10		14	ns
$t_S$	Minimum Setup Time Data to Clock	$t_H \geq 20$ ns	7	15		19		23	ns
$t_H$	Minimum Hold Time Clock to Data	$t_S \geq 20$ ns	1.5	5		5		5	ns
$t_W$	Minimum Pulse Width Clock, or Clear		10	18		22		27	ns
$t_r$ , $t_f$	Maximum Input Rise and Fall Time			500		500		500	ns
$t_{THL}$ , $t_{TLH}$	Maximum Output Rise and Fall Time			15		19		22	ns
$C_{PD}$	Power Dissipation Capacitance (Note 5)	(per flip-flop)	160						pF
$C_{IN}$	Maximum Input Capacitance		5	10		10		10	pF

**Note 5:**  $C_{PD}$  determines the no load dynamic power consumption,  $P_D = C_{PD} V_{CC}^2 f + I_{CC} V_{CC}$ , and the no load dynamic current consumption,  $I_S = C_{PD} V_{CC} f + I_{CC}$ .

**Physical Dimensions** inches (millimeters) unless otherwise noted

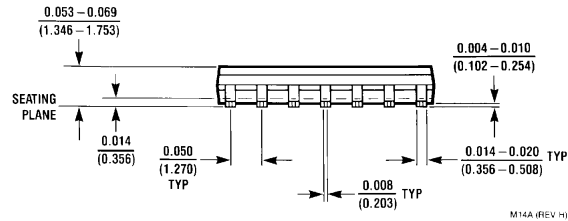
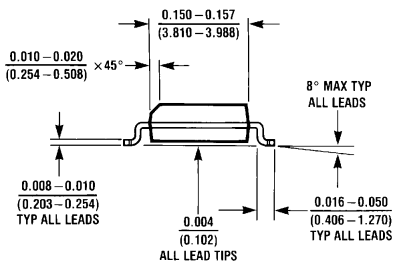
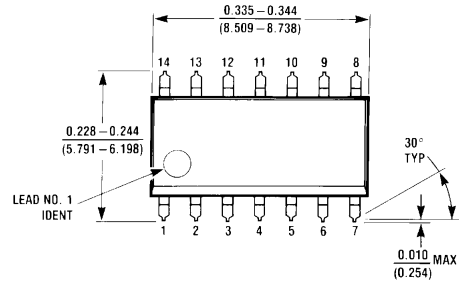

M14A (REV H)

**14-Lead Small Outline Integrated Circuit (SOIC), JEDEC MS-120, 0.150" Narrow  
Package Number M14A**

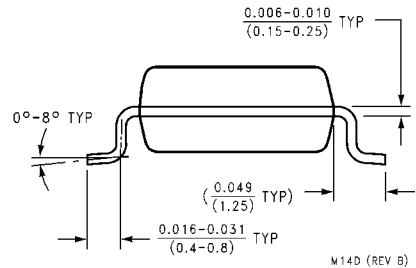
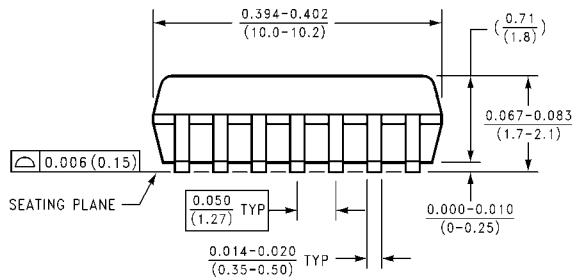
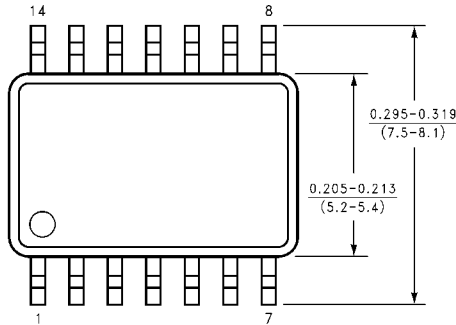

M14D (REV B)

**14-Lead Small Outline Package (SOP), EIAJ TYPE II, 5.3mm Wide  
Package Number M14D**

**Physical Dimensions** inches (millimeters) unless otherwise noted (Continued)



**14-Lead Plastic Dual-In-Line Package (PDIP), JEDEC MS-001, 0.300" Wide Package Number N14A**

**LIFE SUPPORT POLICY**

FAIRCHILD'S PRODUCTS ARE NOT AUTHORIZED FOR USE AS CRITICAL COMPONENTS IN LIFE SUPPORT DEVICES OR SYSTEMS WITHOUT THE EXPRESS WRITTEN APPROVAL OF THE PRESIDENT OF FAIRCHILD SEMICONDUCTOR CORPORATION. As used herein:

1. Life support devices or systems are devices or systems which, (a) are intended for surgical implant into the body, or (b) support or sustain life, and (c) whose failure to perform when properly used in accordance with instructions for use provided in the labeling, can be reasonably expected to result in a significant injury to the user.
2. A critical component in any component of a life support device or system whose failure to perform can be reasonably expected to cause the failure of the life support device or system, or to affect its safety or effectiveness.

[www.fairchildsemi.com](http://www.fairchildsemi.com)